

## OP-CFP-ER4

### 100Gb/s CFP ER4 Transceiver Module

#### PRODUCT FEATURES

- Compliant with 100GBASE-ER4
- Support line rates from 103.125 Gbps to 111.81 Gbps
- Integrated LAN WDM EML TOSA, SOA, ROSA for up to 40 km reach over SMF
- CAUI(10x10G) Electrical Interface and 4-lane 25.78Gb/s optical interface
- Duplex LC optical receptacle
- MDIO Interface for module management
- Single 3.3 V power supply
- Case operating temperature range: 0°C to 70°C
- Power dissipation < 9W



#### APPLICATIONS

- Data Center & 100G Ethernet

#### STANDARD

- Compliant to IEEE 802.3ba
- Compliant to CFP MSA Hardware Specification
- Compliant to CFP MSA Management Interface Specification

#### General Description

The OPTINET CFP ER4 is the optical transceiver module which is a hot pluggable form factor designed for high speed optical networking application. The OPTINET CFP ER4 is designed for

100 Gigabit Ethernet application and provides 100GBASE-ER4 compliant optical interface, CAUI electrical interface and MDIO module management interface. The OPTINET CFP ER4 converts 10-lane 10.3Gb/s electrical data streams to 4-lane LAN-WDM 25.78Gb/s optical output signal and 4-lane LAN-WDM 25.78Gb/s optical input signal to 10-lane 10.3Gb/s electrical data streams. This 10-lane 10.3Gb/s electrical signal is fully compliant with IEEE 802.3ba specification. The high performance Cooled LAN-WDM EA-DFB transmitter and high sensitivity PIN receiver provide superior performance for 100Gigabit Ethernet applications up to 40km links and compliant optical interface with IEEE802.3ba 100GBASE-ER4 requirements. The OPTINET CFP ER4 contains a duplex LC connector for the optical interface and a 148-pin connector for the electrical interface. Figure 1 shows the functional block diagram of OPTINET CFP ER4.

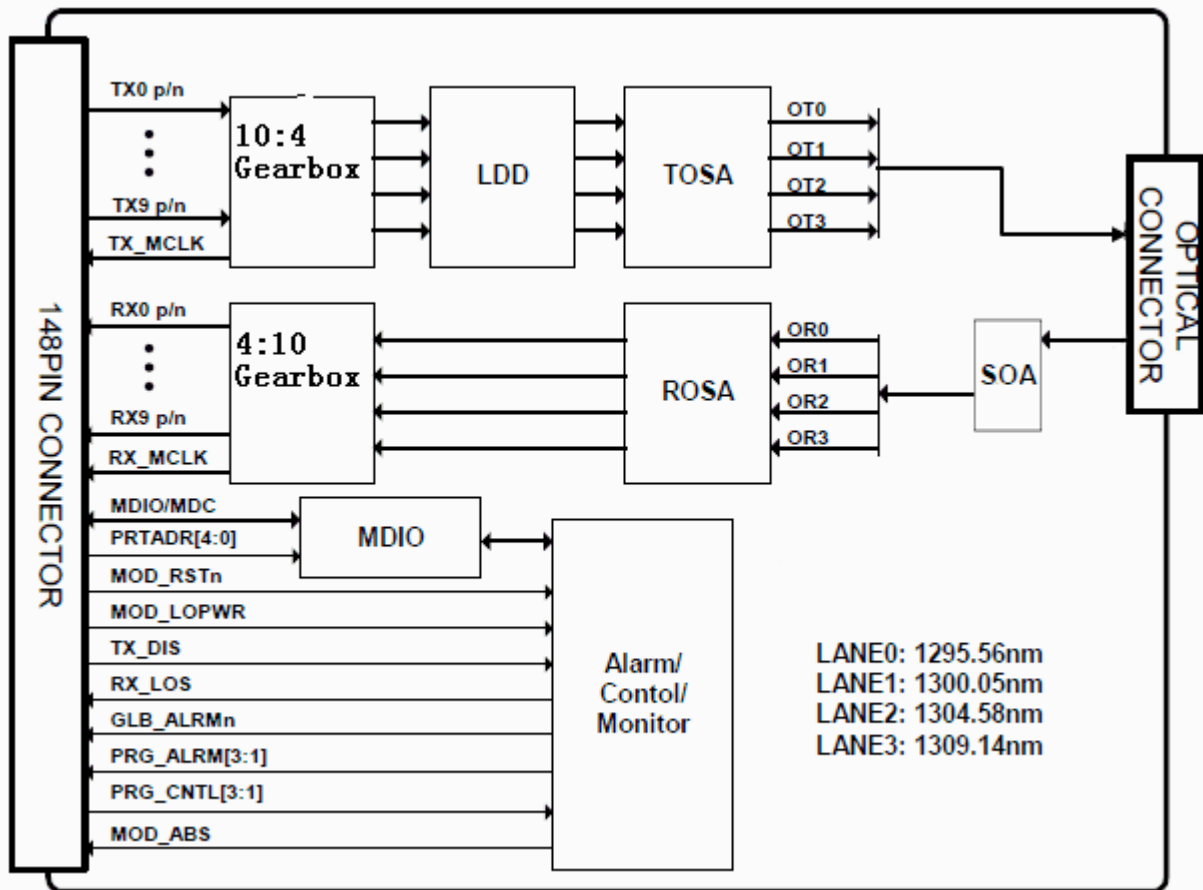

Figure 1. CFP ER4 Optical Transceiver functional block diagram

### Transmitter

The transceiver module receives 10-lane 10.3 Gb/s CAUI electrical inputs. The gearbox multiplexes 10-lane electrical signals to 4-lane electrical signals. The multiplexed 4-lane signals

are fed to the transmitters. The four transmitters convert 4-lane signals to an optical signal through 4 Laser drivers and Lasers diodes which are packaged in the Transmitter Optical Sub-Assembly (TOSA). Each Laser launches optical signal in specific wavelength specified in IEEE802.3ba 100GBASE-ER4 requirements. These 4-lane optical signals will be optically multiplexed into one fiber by 4 to1 Optical WDM MUX which is in the TOSA. The optical output power is held constant by an automatic power control (APC) circuit. The transmitters output can be turned off by TX\_DIS hardware signal and/or through MDIO module management Interface.

### Receiver

The OPTINET CFP ER4 receives 4-lane LAN WDM optical signals. The optical signals are de-multiplexed by 1 to 4 optical DE-MUX and fed into each Receiver Optical Sub-Assembly (ROSA) integrated 1:4 optical DE-MUX. The ROSA converts optical signal to electrical signal. The 4-lane regenerated electrical signals are de-multiplex to 10-lane signals by the 4 to 10 gearbox. The 10-lane signals are compliant with IEEE CAUI interface requirements. Each received optical signal is monitored by the DOM section. The monitored value is reported through the MDIO section. If one or more received optical signal is weaker than the threshold level, RX\_LOS hardware alarm will be launched.

### CFP Pin Map Orientation

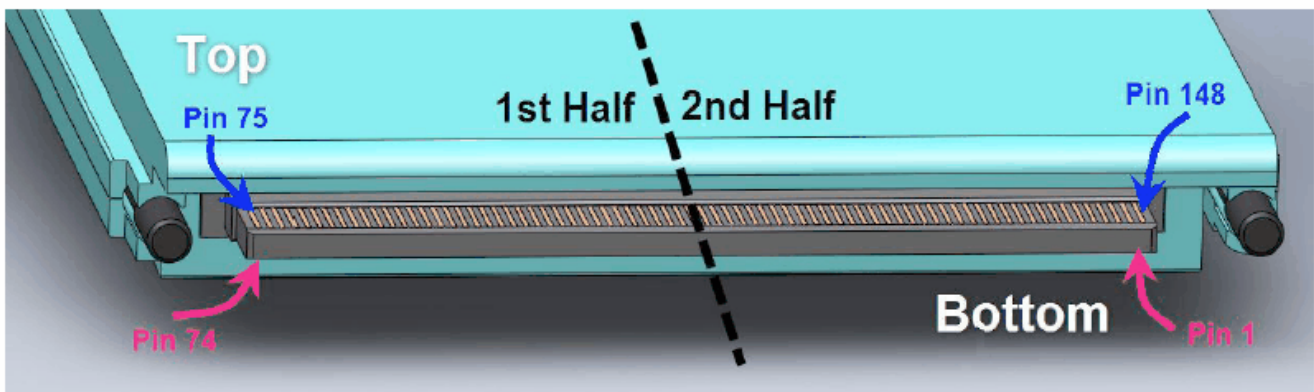

	Top Row (2nd Half)		Bottom Row (2nd Half)		Top Row (1st Half)		Bottom Row (1st Half)
148	GND	1	3.3V_GND	111	GND	38	MOD_ABS
147	REFCLKn	2	3.3V_GND	110	N.C.	39	MOD_RSTn
146	REFCLKp	3	3.3V_GND	109	N.C.	40	RX_LOS
145	GND	4	3.3V_GND	108	GND	41	GLB_ALRMn
144	N.C.	5	3.3V_GND	107	RX9n	42	PRTADR4
143	N.C.	6	3.3V	106	RX9p	43	PRTADR3
142	GND	7	3.3V	105	GND	44	PRTADR2
141	TX9n	8	3.3V	104	RX8n	45	PRTADR1
140	TX9p	9	3.3V	103	RX8p	46	PRTADR0
139	GND	10	3.3V	102	GND	47	MDIO
138	TX8n	11	3.3V	101	RX7n	48	MDC
137	TX8p	12	3.3V	100	RX7p	49	GND
136	GND	13	3.3V	99	GND	50	VND_IO_F
135	TX7n	14	3.3V	98	RX6n	51	VND_IO_G
134	TX7p	15	3.3V	97	RX6p	52	GND
133	GND	16	3.3V_GND	96	GND	53	VND_IO_H
132	TX6n	17	3.3V_GND	95	RX5n	54	VND_IO_J
131	TX6p	18	3.3V_GND	94	RX5p	55	3.3V_GND
130	GND	19	3.3V_GND	93	GND	56	3.3V_GND
129	TX5n	20	3.3V_GND	92	RX4n	57	3.3V_GND
128	TX5p	21	VND_IO_A	91	RX4p	58	3.3V_GND
127	GND	22	VND_IO_B	90	GND	59	3.3V_GND
126	TX4n	23	GND	89	RX3n	60	3.3V
125	TX4p	24	(TX_MCLKn)	88	RX3p	61	3.3V
124	GND	25	(TX_MCLKp)	87	GND	62	3.3V
123	TX3n	26	GND	86	RX2n	63	3.3V
122	TX3p	27	VND_IO_C	85	RX2p	64	3.3V
121	GND	28	VND_IO_D	84	GND	65	3.3V
120	TX2n	29	VND_IO_E	83	RX1n	66	3.3V
119	TX2p	30	PRG_CNTL1	82	RX1p	67	3.3V
118	GND	31	PRG_CNTL2	81	GND	68	3.3V
117	TX1n	32	PRG_CNTL3	80	RX0n	69	3.3V
116	TX1p	33	PRG_ALRM1	79	RX0p	70	3.3V_GND
115	GND	34	PRG_ALRM2	78	GND	71	3.3V_GND
114	TX0n	35	PRG_ALRM3	77	(RX_MCLKn)	72	3.3V_GND
113	TX0p	36	TX_DIS	76	(RX_MCLKp)	73	3.3V_GND
112	GND	37	MOD_LOPWR	75	GND	74	3.3V_GND

Figure 2 CFP ER4 optical transceiver pin-out

Table 1 CFP optical transceiver pin descriptions

Pin no.	Name	Logic	Description
1	3.3V_GND		3.3V Module Supply Voltage Return Ground, can be separate or tied together with Signal Ground
2	3.3V_GND		
3	3.3V_GND		
4	3.3V_GND		
5	3.3V_GND		



**Optinet Technology Co., Ltd**

Add: 4th Floor Xiufeng Industrial Park, Buji Street, Longgang District, Shenzhen, China 518112

Tel: +86-755-28471034 Fax: +86-755-61824579

www.optinetec.com sales@optinetec.com

6	3.3V		
7	3.3V		
8	3.3V		
9	3.3V		
10	3.3V		
11	3.3V		
12	3.3V		
13	3.3V		
14	3.3V		
15	3.3V		
16	3.3V_GND		3.3V Module Supply Voltage Return Ground, can be separate or tied together with Signal Ground
17	3.3V_GND		
18	3.3V_GND		
19	3.3V_GND		
20	3.3V_GND		
21	NUC		Module Vendor I/O. Must No Connect at host board
22	NUC		Module Vendor I/O. Must No Connect at host board
23	GND		
24	TX_M CLKn		TX Monitor Clock Output (Negative)
25	TX_M CLKp		TX Monitor Clock Output (Positive)
26	GND		
27	NUC		Module Vendor I/O. Must No Connect at host board
28	NUC		Module Vendor I/O. Must No Connect at host board

Pin no.	Name	Logic	Description
29	NUC		Module Vendor I/O. Must No Connect at host board
30	PRG_CNTL1	LVC MOS w/ PUR	Programmable Control 1 set over MDIO, M SA Default: TRXIC_RSTn, TX & RX ICs reset, "0": reset, "1" or NC: enabled = not used
31	PRG_CNTL2	LVC MOS w/ PUR	Programmable Control 2 set over MDIO, M SA Default: Hardware Interlock LSB, "00": ≤8W, "01": ≤16W, "10": ≤24W, "11" or NC: ≤32W = not used
32	PRG_CNTL3	LVC MOS w/ PUR	Programmable Control 2 set over M DIO, M SA Default: Hardware Interlock M SB, "00": ≤8W, "01": ≤16W, "10": ≤24W, "11" or NC: ≤32W = not used
33	PRG_ALARM 1	LVC MOS	Programmable Alarm 1 set over MDIO, M SA Default: HIPWR_ON, "1": module, power up completed, "0": module not high powered up
34	PRG_ALARM 2	LVC MOS	Programmable Alarm 2 set over MDIO, M SA Default: M OD_READY, "1": Ready, "0": not Ready,
35	PRG_ALARM 3	LVC MOS	Programmable Alarm 3 set over MDIO, M SA Default: M OD_FAULT, fault detected, "1": Fault, "0": No Fault
36	TX_DIS	LVC MOS w/ PUR	Transmitter Disable for all lanes, "1" or NC = transmitter disabled, "0" = transmitter enabled
37	MOD_LOPWR	LVC MOS w/ PUR	Module Low Power Mode. "1" or NC: module in low power (safe) mode, "0": power-on enabled



**Optinet Technology Co., Ltd**

Add: 4th Floor Xiufeng Industrial Park, Buji Street, Longgang District, Shenzhen, China 518112

Tel: +86-755-28471034 Fax: +86-755-61824579

www.optinetec.com sales@optinetec.com

38	MOD_ABS		Module Absent. "1" or NC: module absent, "0": module present, Pull Up Resistor on Host
39	MOD_RSTn	LVCM OS w/ PUR	Module Reset. "0" resets the module, "1" or NC = module enabled, Pull Down Resistor in Module
40	RX_LOS	LVCM OS	Receiver Loss of Optical Signal, "1": low optical signal, "0": normal condition
41	GLB_ALARM n	LVCM OS	Global Alarm. "0": alarm condition in any M DIO Alarm register, "1": no alarm condition, Open Drain, Pull Up Resistor on Host
42	PRTADR4	1.2V CM OS	M DIO Physical Port address bit 4
43	PRTADR3	1.2V CM OS	M DIO Physical Port address bit 3
44	PRTADR2	1.2V CM OS	M DIO Physical Port address bit 2
45	PRTADR1	1.2V CM OS	M DIO Physical Port address bit 1
46	PRTADR0	1.2V CM OS	M DIO Physical Port address bit 0
47	M DIO	1.2V CM OS	Management Data I/O bi-directional data (electrical specs as per 802.3ae and ba)
48	M DC	1.2V CM OS	Management Data Clock (electrical specs as per 802.3ae and ba)
49	GND		
50	NUC		Module Vendor I/O. Must No Connect at host board
51	NUC		Module Vendor I/O. Must No Connect at host board
52	GND		
53	NUC		Module Vendor I/O. Must No Connect at host board
54	NUC		Module Vendor I/O. Must No Connect at host board

Pin no.	Name	Logic	Description
55	3.3V_GND		3.3V Module Supply Voltage Return Ground, can be separate or tied together with Signal Ground
56	3.3V_GND		
57	3.3V_GND		
58	3.3V_GND		
59	3.3V_GND		
60	3.3V		3.3V Module Supply Voltage
61	3.3V		
62	3.3V		
63	3.3V		
64	3.3V		
65	3.3V		
66	3.3V		
67	3.3V		
68	3.3V		
69	3.3V		
70	3.3V_GND		3.3V Module Supply Voltage Return Ground, can be separate or tied together with Signal Ground
71	3.3V_GND		

**Optinet Technology Co., Ltd**

Add: 4th Floor Xiufeng Industrial Park, Buji Street, Longgang District, Shenzhen, China 518112

Tel: +86-755-28471034 Fax: +86-755-61824579

www.optinetec.com sales@optinetec.com

72	3.3V_GND		
73	3.3V_GND		
74	3.3V_GND		
75	3.3V_GND		
76	RX_MCLKp		RX Monitor Clock Output (Positive)
77	RX_MCLKn		RX Monitor Clock Output (Negative)
78	GND		
79	RX0p	HS I/O	Lane 0 Receiver Output (Positive)
80	RX0n	HS I/O	Lane 0 Receiver Output (Negative)
81	GND		
82	RX1p	HS I/O	Lane 1 Receiver Output (Positive)
83	RX1n	HS I/O	Lane 1 Receiver Output (Negative)
84	GND		
85	RX2p	HS I/O	Lane 2 Receiver Output (Positive)
86	RX2n	HS I/O	Lane 2 Receiver Output (Negative)
87	GND		
88	RX3p	HS I/O	Lane 3 Receiver Output (Positive)
89	RX3n	HS I/O	Lane 3 Receiver Output (Negative)
90	GND		
91	RX4p	HS I/O	Lane 4 Receiver Output (Positive)
92	RX4n	HS I/O	Lane 4 Receiver Output (Negative)
93	GND		
94	RX5p	HS I/O	Lane 5 Receiver Output (Positive)
95	RX5n	HS I/O	Lane 5 Receiver Output (Negative)
96	GND		
97	RX6p	HS I/O	Lane 6 Receiver Output (Positive)
98	RX6n	HS I/O	Lane 6 Receiver Output (Negative)
99	GND		
100	RX7p	HS I/O	Lane 7 Receiver Output (Positive)
101	RX7n	HS I/O	Lane 7 Receiver Output (Negative)
102	GND		
103	RX8p	HS I/O	Lane 8 Receiver Output (Positive)
104	RX8n	HS I/O	Lane 8 Receiver Output (Negative)
105	GND		
106	RX9p	HS I/O	Lane 9 Receiver Output (Positive)
107	RX9n	HS I/O	Lane 9 Receiver Output (Negative)
108	GND		
109	NC		Not Connected Internally



**Optinet Technology Co., Ltd**

Add: 4th Floor Xiufeng Industrial Park, Buji Street, Longgang District, Shenzhen, China 518112

Tel: +86-755-28471034 Fax: +86-755-61824579

www.optinetec.com sales@optinetec.com

110	NC		Not Connected Internally
111	GND		
112	GND		
113	TX0p	HS I/O	Lane 0 Transmitter Input (Positive)
114	TX0n	HS I/O	Lane 0 Transmitter Input (Negative)
115	GND		
116	TX1p	HS I/O	Lane 1 Transmitter Input (Positive)
117	TX1n	HS I/O	Lane 1 Transmitter Input (Negative)
118	GND		
119	TX2p	HS I/O	Lane 2 Transmitter Input (Positive)
120	TX2n	HS I/O	Lane 2 Transmitter Input (Negative)
121	GND		
122	TX3p	HS I/O	Lane 3 Transmitter Input (Positive)
123	TX3n	HS I/O	Lane 3 Transmitter Input (Negative)
124	GND		
125	TX4p	HS I/O	Lane 4 Transmitter Input (Positive)
126	TX4n	HS I/O	Lane 4 Transmitter Input (Negative)
127	GND		
128	TX5p	HS I/O	Lane 5 Transmitter Input (Positive)
129	TX5n	HS I/O	Lane 5 Transmitter Input (Negative)
130	GND		
131	TX6p	HS I/O	Lane 6 Transmitter Input (Positive)
132	TX6n	HS I/O	Lane 6 Transmitter Input (Negative)
133	GND		
134	TX7p	HS I/O	Lane 7 Transmitter Input (Positive)
135	TX7n	HS I/O	Lane 7 Transmitter Input (Negative)
136	GND		
137	TX8p	HS I/O	Lane 8 Transmitter Input (Positive)
138	TX8n	HS I/O	Lane 8 Transmitter Input (Negative)
139	GND		
140	TX9p	HS I/O	Lane 9 Transmitter Input (Positive)
141	TX9n	HS I/O	Lane 9 Transmitter Input (Negative)
142	GND		
143	NC		Not Connected Internally
144	NC		Not Connected Internally
145	GND		
146	REFCLKp		Reference Clock Input (Positive)
147	REFCLKn		Reference Clock Input (Negative)



148	GND		
-----	-----	--	--

## Absolute Maximum Ratings

Parameter	Symbol	Min.	Typ.	Max.	Unit	Note
Storage Temperature	Ts	-40	-	85	°C	
Relative Humidity	RH	5	-	95	%	
Power Supply Voltage	VCC	-0.3	-	4	V	
Signal Input Voltage		Vcc-0.3	-	Vcc+0.3	V	
Receive Input Optical Power (Damage threshold)	Pdmg			5.5	dBm	

## Low Speed Electrical Characteristics

Parameter	Symbol	Min	Typ.	Max	Unit	Notes
Supply currents and voltages						
Voltage	Vcc	3.2	3.3	3.4	V	With Respect to GND
Supply current	Icc			2.7	A	
Power dissipation	Pwr			9.0	W	
Power dissipation (low power mode)	Plp			2.0	W	
Low speed control and sense signals, 3.3 V LVCMOS						
Outputs low voltage	VoL	-0.3		0.2	V	
Output high voltage	VoH	Vcc-0.2		Vcc+0.3	V	
Input low voltage	ViL	-0.3		0.8	V	
Input high voltage	ViH	2		Vcc+ 0.3	V	
Input leakage current	IiN	-10		10	μA	
Low speed control and sense signals, 1.2 V LVCMOS						
Outputs low voltage	VoL	-0.3		0.2	V	
Output high voltage	VoH	1.0		1.5	V	
Input low voltage	ViL	-0.3		0.36	V	
Input high voltage	ViH	0.84		1.5	V	
Input leakage current	IiN	-100		100	μA	

## MDIO Management Interface

The OPTINET CFP ER4 supports the MDIO interface specified in IEEE802.3 Clause 45. This 2-wire management data I/O interface is provided for the module status monitoring and control. The management data clock (MDC) provides clocking for the data that is passed on the MDIO port. Five further pins allow for loading of a port address (PORT\_ADDR0-4) into the module.



Optinet Technology Co., Ltd

Add: 4th Floor Xiufeng Industrial Park, Buji Street, Longgang District, Shenzhen, China 518112

Tel: +86-755-28471034 Fax: +86-755-61824579

www.optinetec.com sales@optinetec.com

The CFP transceiver supports MDIO pages 8000h NVR 1 Based ID registers, 8080h NVR 2 Extended ID registers, 8100h NVR 3 network lane specific registers, and pages A000h CFP module VR 1 registers, A080h MLG VR 1 registers, A200h network lane VR 1 registers, A280h network lane VR 2 registers.

Details of the protocol and interface are explicitly described in CFP MSA Management Interface Specification. Please refer to the specifications for design reference.

Starting Address in Hex	Ending Address in Hex	Access Type	Allocated Size	Data Bit Width	Table Name and Description
0000	7FFF	N/A	32768	N/A	Reserved for IEEE 802.3 Use.
8000	807F	RO	128	8	CFP NVR 1. Basic ID registers.
8080	80FF	RO	128	8	CFP NVR 2. Extended ID registers.
8100	817F	RO	128	8	CFP NVR 3. Network lane specific registers.
8180	81FF	RO	128	8	CFP NVR 4.
8200	83FF	RO	4x128	N/A	MSA Reserved.
8400	847F	RO	128	8	Vendor NVR 1. Vendor data registers.
8480	84FF	RO	128	8	Vendor NVR 2. Vendor data registers.
8500	87FF	RO	6x128	N/A	Reserved by CFP MSA.
8800	887F	R/W	128	8	User NVR 1. User data registers.
8880	88FF	R/W	128	8	User NVR 2. User data registers.
8900	8EFF	RO	12x128	N/A	Reserved by CFP MSA.
8F00	8FFF	N/A	2x128	N/A	Reserved for User private use
9000	9FFF	RO	4096	N/A	Reserved for vendor private use.
A000	A07F	R/W	128	16	CFP Module VR 1. CFP Module level control and DDM registers.
A080	A0FF	R/W	128	16	MLG VR 1. MLG Management Interface registers
A100	A1FF	RO	2x128	N/A	Reserved by CFP MSA.
A200	A27F	R/W	128	16	Network Lane VR 1. Network lane specific registers.
A280	A2FF	R/W	128	16	Network Lane VR 2. Network lane specific registers.
A300	A37F	R/W	128	16	Network Lane VR 3. Network Lane n Vendor Specific FAWS Registers
A380	A3FFF	RO	128	N/A	Reserved by CFP MSA
A400	A47F	R/W	128	16	Host Lane VR 1. Host lane specific registers.
A480	ABFF	RO	15x128	N/A	Reserved by CFP MSA.
AC00	AFFF	R/W	8x128	16	Common Data Block Registers
B000	BFFF	R/W	32x128	16	Allocated for OIF MSA-100GLH modules
C000	FFFF	RO	4x4096	N/A	Reserved by CFP MSA.



Optinet Technology Co., Ltd

Add: 4th Floor Xiufeng Industrial Park, Buji Street, Longgang District, Shenzhen, China 518112

Tel: +86-755-28471034 Fax: +86-755-61824579

www.optinetec.com sales@optinetec.com

## Optical Characteristics

Parameter	Symbol	Min	Typ.	Max	Unit	Notes
<b>Transmitter</b>						
Signaling rate, each lane			25.78125		Gbps	
Lane wavelength (range)		1294.53	1295.56	1296.59	nm	
		1299.02	1300.05	1301.09	nm	
		1303.54	1304.58	1305.63	nm	
		1308.09	1309.14	1310.19	nm	
Rate tolerance		-100		100	ppm	From nominal rate
Side-mode suppression ratio	SMSR	30			dB	
Total launch power				8.9	dBm	
Average launch power, each lane	Pavg	-2.9		2.9	dBm	
Extinction Ratio	ER	8			dB	
Optical modulation amplitude, each lane (OMA)	OMA	0.1			dBm	
Difference in launch power between any two lanes (OMA)				3.6	dB	
Transmitter and Dispersion Penalty, each lane	TDP			2.5	dB	
Average launch power of OFF transmitter, each lane				-30	dBm	
Transmitter reflectance				-12	dB	
Transmitter eye mask {X1, X2, X3, Y1, Y2, Y3}		{0.25, 0.4, 0.45, 0.25, 0.28, 0.4}				
<b>Receiver</b>						
Signaling rate, each lane			25.78125		Gbps	
Rate tolerance		-100		100	ppm	From normal rate
Average receive power, each lane	Pavg	-20.9		4.5	dBm	
Receive power, each lane (OMA)				4.5	dBm	
Difference in receiver power between any two lanes (OMA)				4.5	dB	
Receiver Sensitivity (OMA), each lane	Rsen			-21.4	dBm	1
Stressed Receiver Sensitivity (OMA), each lane	SRS			-17.9	dBm	
Stressed receiver sensitivity test conditions						
Vertical eye closure penalty, each lane	VECP		3.5		dB	
Stressed sys J2 jitter, each lane	J2		0.3		UI	2
Stressed sys J9 jitter, each lane	J9		0.47		UI	2

Receiver reflectance				-26	dB	
LOS Assert	Plos_on	-36			dBm	
LOS Deassert	Plos_off			-24	dBm	
LOS Hysteresis		0.5			dB	

1. Receiver sensitivity (OMA), each lane, is informative.
2. Vertical eye closure penalty, stressed eye J2 Jitter, and stressed eye J9 Jitter are test conditions for measuring stressed receiver sensitivity. They are not characteristics of the receiver.

### Outline Dimensions

Units in mm

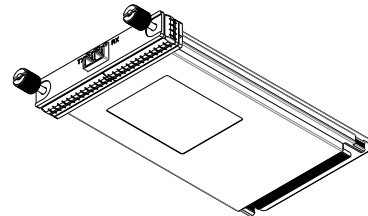
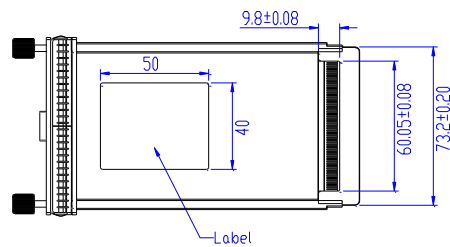
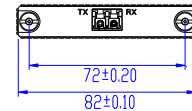
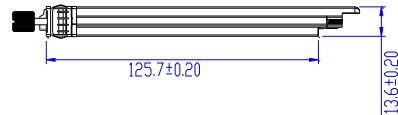
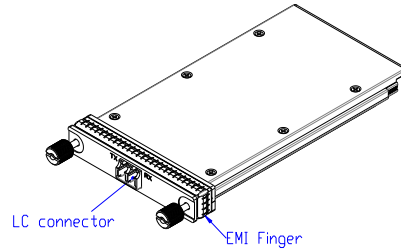
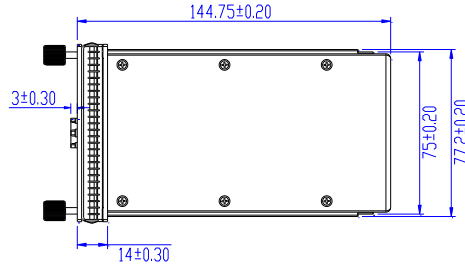

### Ordering Information

Part Number	Product Description
OP-CFP-ER4	100G CFP ER4 LWDM 40km LC DDM