

## OP-S16G31-20

14.025Gbps SFP+ Transceiver, Single Mode, 1310nm 20km Reach

### Product Features

- Supports up to 14.025Gbps bit rates
- Hot-pluggable SFP+ footprint
- 1310nm DFB laser and PIN photodiode, up to 20km for SMF transmission
- Compliant with SFP+ MSA and SFF-8472 with duplex LC receptacle
- Compatible with RoHS
- Single +3.3V power supply
- Real Time Digital Diagnostic Monitoring
- Operating case temperature:
- Standard: 0 to +70°C

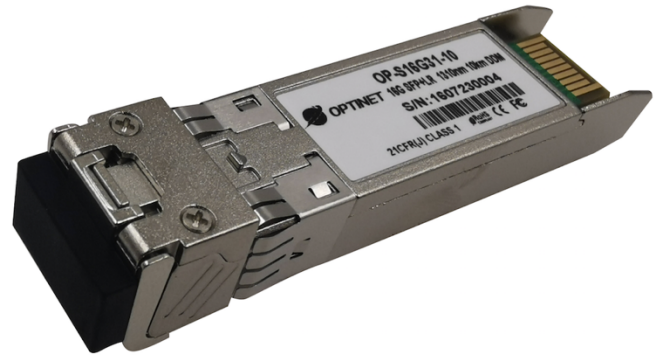

### Applications

- 4.25/8.5/14.025G Fibre channel

### Description

The SFP+ transceivers are high performance, cost effective modules supporting data rate of 14.025Gbps and 20km transmission distance with SMF.

The transceiver consists of three sections: a DFB laser transmitter, a PIN photodiode integrated with a trans-impedance preamplifier (TIA) and MCU control unit. All modules satisfy class I laser safety requirements.

The transceivers are compatible with SFP Multi-Source Agreement and SFF-8472 digital diagnostics functions.

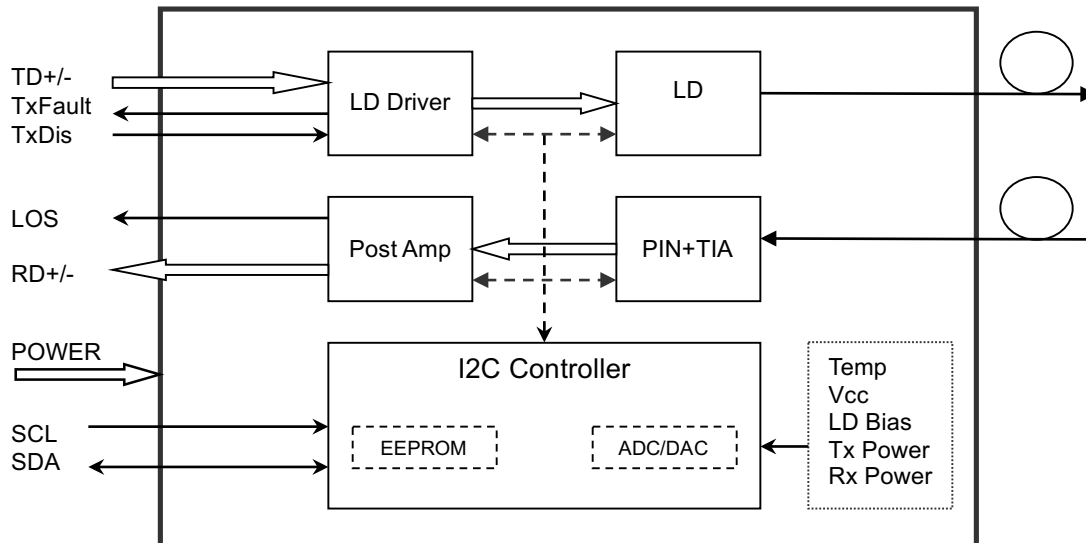



Optinet Technology Co., Ltd

Add: 4th Floor Xiufeng Industrial Park, Buji Street, Longgang District, Shenzhen, China 518112

Tel: +86-755-28471034 Fax: +86-755-61824579

www.optinetec.com sales@optinetec.com

## Absolute Maximum Ratings

Parameter	Symbol	Min	Max	Unit
Supply Voltage	V <sub>cc</sub>	-0.5	4.5	V
Storage Temperature	T <sub>s</sub>	-40	+85	°C
Operating Humidity	-	5	85	%

## Recommended Operating Conditions

Parameter	Symbol	Min	Typical	Max	Unit
Operating Case Temperature	T <sub>c</sub>	0		+70	°C
Power Supply Voltage	V <sub>cc</sub>	3.135	3.30	3.465	V
Power Supply Current	I <sub>cc</sub>			300	mA
Data Rate			14.025		Gbps

## Optical and Electrical Characteristics

Parameter	Symbol	Min	Typical	Max	Unit	Notes
<b>Transmitter</b>						
Centre Wavelength	$\lambda_c$	1270	1310	1350	nm	
Spectral Width (-20dB)	$\Delta\lambda$			1	nm	
Side-Mode Suppression Ratio	SMSR	30	-		dB	
Average Output Power	P <sub>out</sub>	-5		-0.5	dBm	1
Extinction Ratio	ER	3.5			dB	
Data Input Swing Differential	V <sub>IN</sub>	180		850	mV	2
Input Differential Impedance	Z <sub>IN</sub>	90	100	110	$\Omega$	
TX Disable	Disable	2.0		V <sub>cc</sub>	V	TX Disable
	Enable	0		0.8	V	
TX Fault	Fault	2.0		V <sub>cc</sub>	V	TX Fault
	Normal	0		0.8	V	
<b>Receiver</b>						
Centre Wavelength	$\lambda_c$	<b>1260</b>		<b>1600</b>	nm	
Receiver Sensitivity				-12	dBm	3
Receiver Overload		0.5			dBm	3



**Optinet Technology Co., Ltd**

Add: 4th Floor Xiufeng Industrial Park, Buji Street, Longgang District, Shenzhen, China 518112  
 Tel: +86-755-28471034 Fax: +86-755-61824579  
 www.optinetec.com sales@optinetec.com

LOS De-Assert	LOS <sub>D</sub>			-13	dBm	
LOS Assert	LOS <sub>A</sub>	-30			dBm	
LOS Hysteresis		0.5			dB	
Data Output Swing Differential	V <sub>out</sub>	300		900	mV	4
LOS	High	2.0		V <sub>cc</sub>	V	
	Low			0.8	V	

**Notes:**

1. The optical power is launched into SMF.
2. PECL input, internally AC-coupled and terminated.
3. Measured with a PRBS 2<sup>31</sup>-1 test pattern @14025Mbps, BER ≤1×10<sup>-12</sup>.
4. Internally AC-coupled.

## Timing and Electrical

Parameter	Symbol	Min	Typical	Max	Unit
Tx Disable Negate Time	t <sub>on</sub>			1	ms
Tx Disable Assert Time	t <sub>off</sub>			10	μs
Time To Initialize, including Reset of Tx Fault	t <sub>init</sub>			300	ms
Tx Fault Assert Time	t <sub>fault</sub>			100	μs
Tx Disable To Reset	t <sub>reset</sub>	10			μs
LOS Assert Time	t <sub>loss_on</sub>			100	μs
LOS De-assert Time	t <sub>loss_off</sub>			100	μs
Serial ID Clock Rate	f <sub>serial_clock</sub>		100	400	KHz
MOD_DEF (0:2)-High	V <sub>H</sub>	2		V <sub>cc</sub>	V
MOD_DEF (0:2)-Low	V <sub>L</sub>			0.8	V

## Diagnostics

Parameter	Range	Unit	Accuracy	Calibration
Temperature	0 to +70	°C	±3°C	Internal
Voltage	3.0 to 3.6	V	±3%	Internal



**Optinet Technology Co., Ltd**

Add: 4th Floor Xiufeng Industrial Park, Buji Street, Longgang District, Shenzhen, China 518112

Tel: +86-755-28471034 Fax: +86-755-61824579

www.optinetec.com sales@optinetec.com

Bias Current	0 to 15	mA	±10%	Internal
TX Power	-7.8 to -0.5	dBm	±3dB	Internal
RX Power	-16 to -1	dBm	±3dB	Internal

## Digital Diagnostic Memory Map

The transceivers provide serial ID memory contents and diagnostic information about the present operating conditions by the 2-wire serial interface (SCL, SDA).

The diagnostic information with internal calibration or external calibration all are implemented, including received power monitoring, transmitted power monitoring, bias current monitoring, supply voltage monitoring and temperature monitoring.

The digital diagnostic memory map specific data field defines as following.

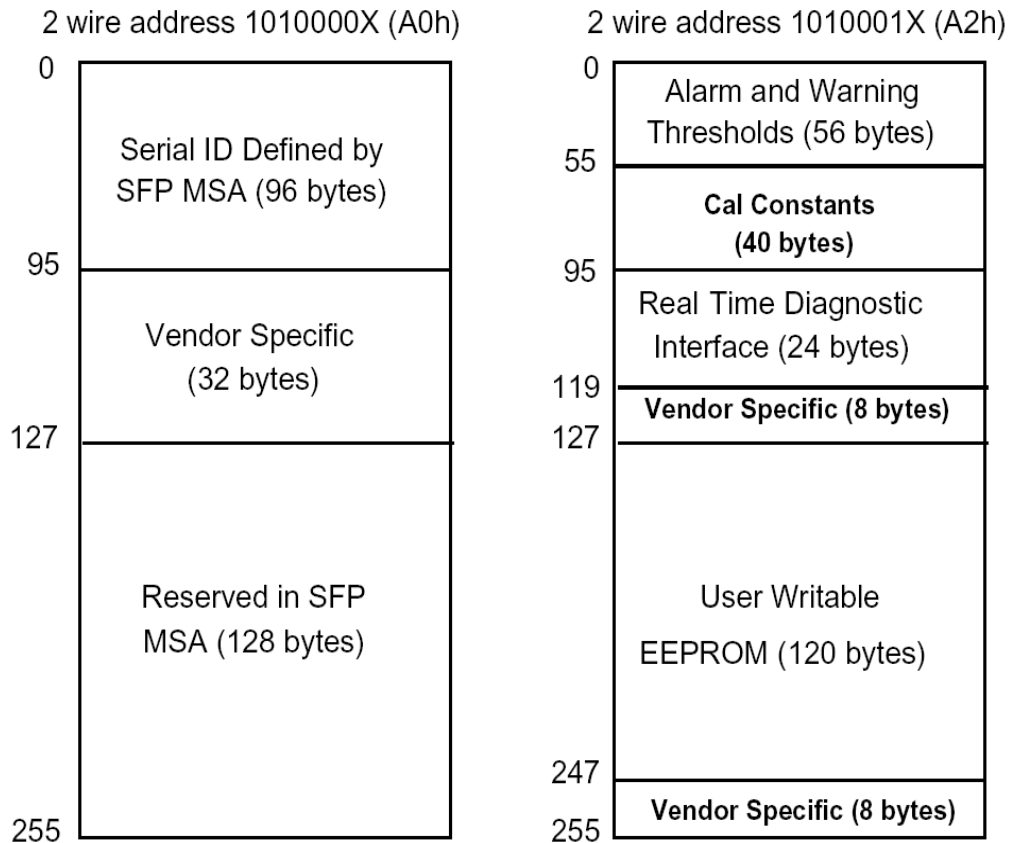

## Pin Descriptions

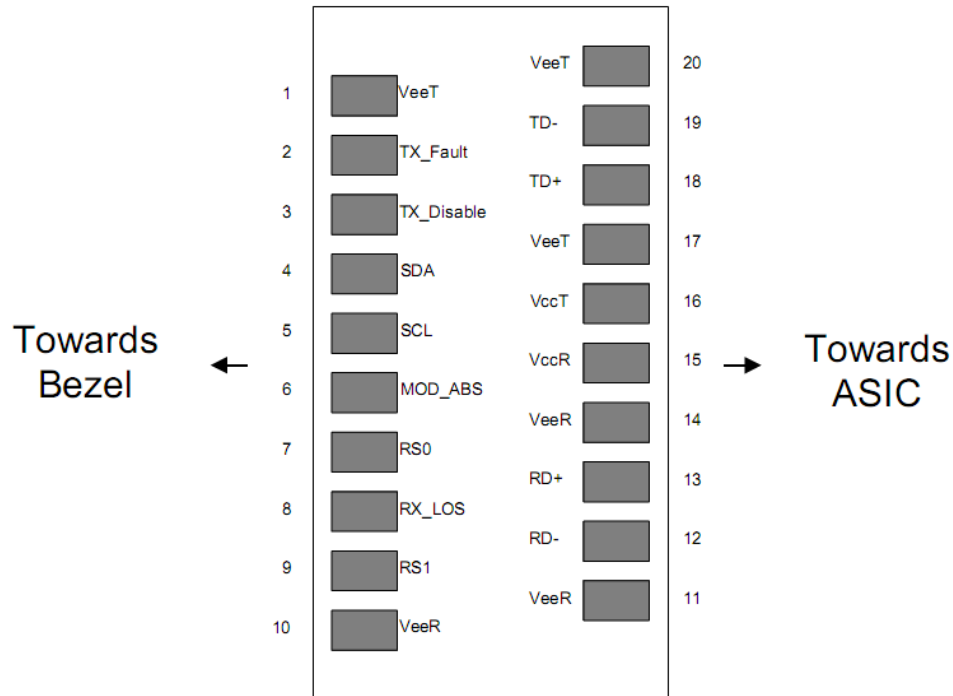

Pin	Signal Name	Description	Plug Seq.	Notes
1	V <sub>EET</sub>	Transmitter Ground	1	
2	TX FAULT	Transmitter Fault Indication	3	Note 1
3	TX DISABLE	Transmitter Disable	3	Note 2
4	SDA	SDA Serial Data Signal	3	
5	SCL	SCL Serial Clock Signal	3	
6	MOD_ABS	Module Absent. Grounded within the module	3	
7	RS0	Not Connected	3	
8	LOS	Loss of Signal	3	Note 3
9	RS1	Not Connected	3	
10	V <sub>EER</sub>	Receiver ground	1	
11	V <sub>EER</sub>	Receiver ground	1	
12	RD-	Inv. Received Data Out	3	Note 4
13	RD+	Received Data Out	3	Note 4
14	V <sub>EER</sub>	Receiver ground	1	
15	V <sub>CCR</sub>	Receiver Power Supply	2	
16	V <sub>CCT</sub>	Transmitter Power Supply	2	
17	V <sub>EET</sub>	Transmitter Ground	1	
18	TD+	Transmit Data In	3	Note 5

19	TD-	Inv. Transmit Data In	3	Note 5
20	V <sub>EET</sub>	Transmitter Ground	1	

Notes:

Plug Seq.: Pin engagement sequence during hot plugging.

- 1) TX Fault is an open collector output, which should be pulled up with a 4.7k~10kΩ resistor on the host board to a voltage between 2.0V and V<sub>cc</sub>+0.3V. Logic 0 indicates normal operation; Logic 1 indicates a laser fault of some kind. In the low state, the output will be pulled to less than 0.8V.
- 2) Laser output disabled on TDIS >2.0V or open, enabled on TDIS <0.8V.
- 3) LOS is open collector output. Should be pulled up with 4.7k~10kΩ on host board to a voltage between 2.0V and 3.6V. Logic 0 indicates normal operation; logic 1 indicates loss of signal.
- 4) RD-/+ : These are the differential receiver outputs. They are internally AC-coupled 100 differential lines which should be terminated with 100Ω (differential) at the user SERDES.
- 5) TD-/+ : These are the differential transmitter inputs. They are internally AC-coupled, differential lines with 100Ω differential termination inside the module.

### Recommended Interface Circuit

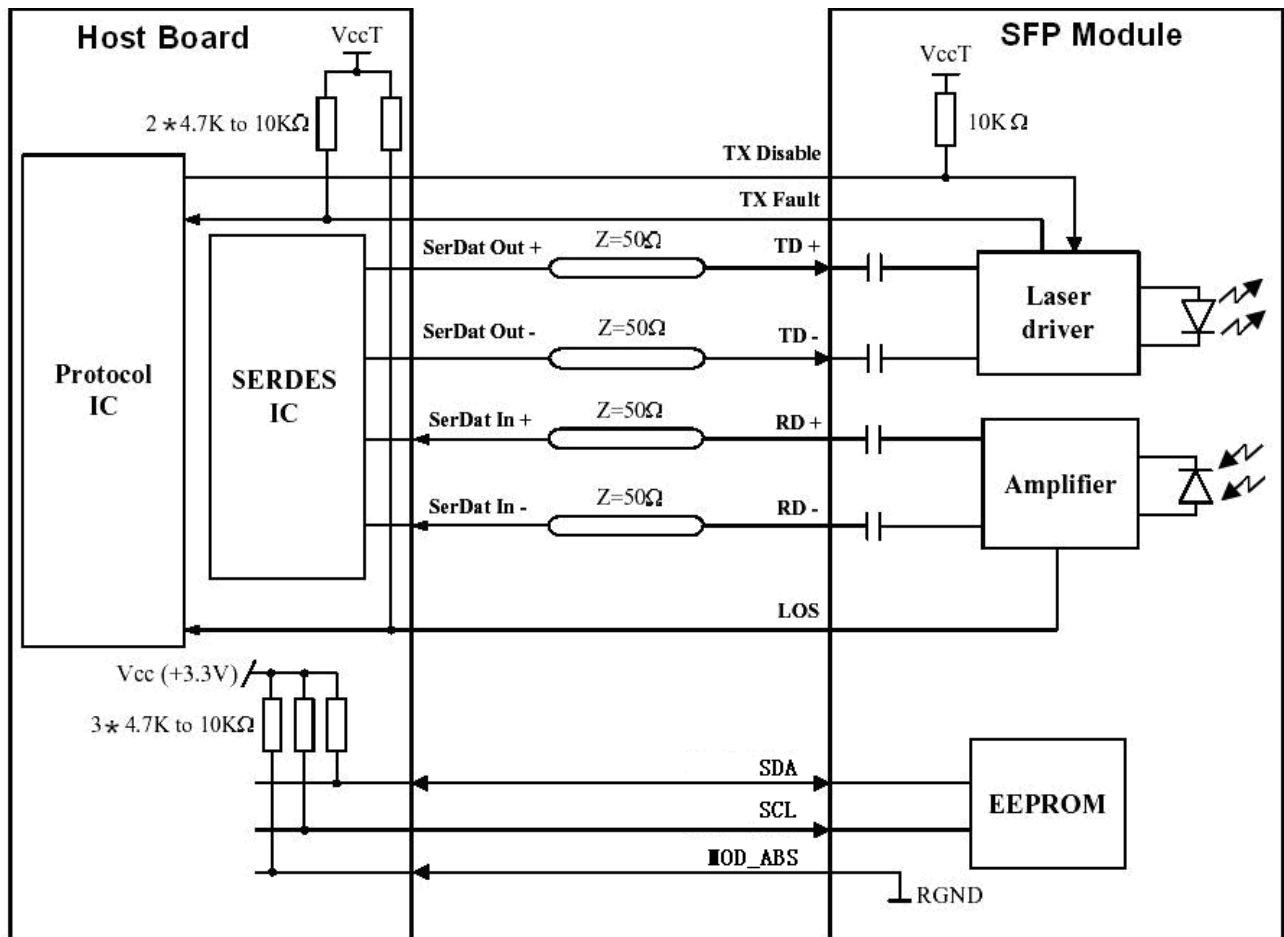

## Mechanical Dimensions

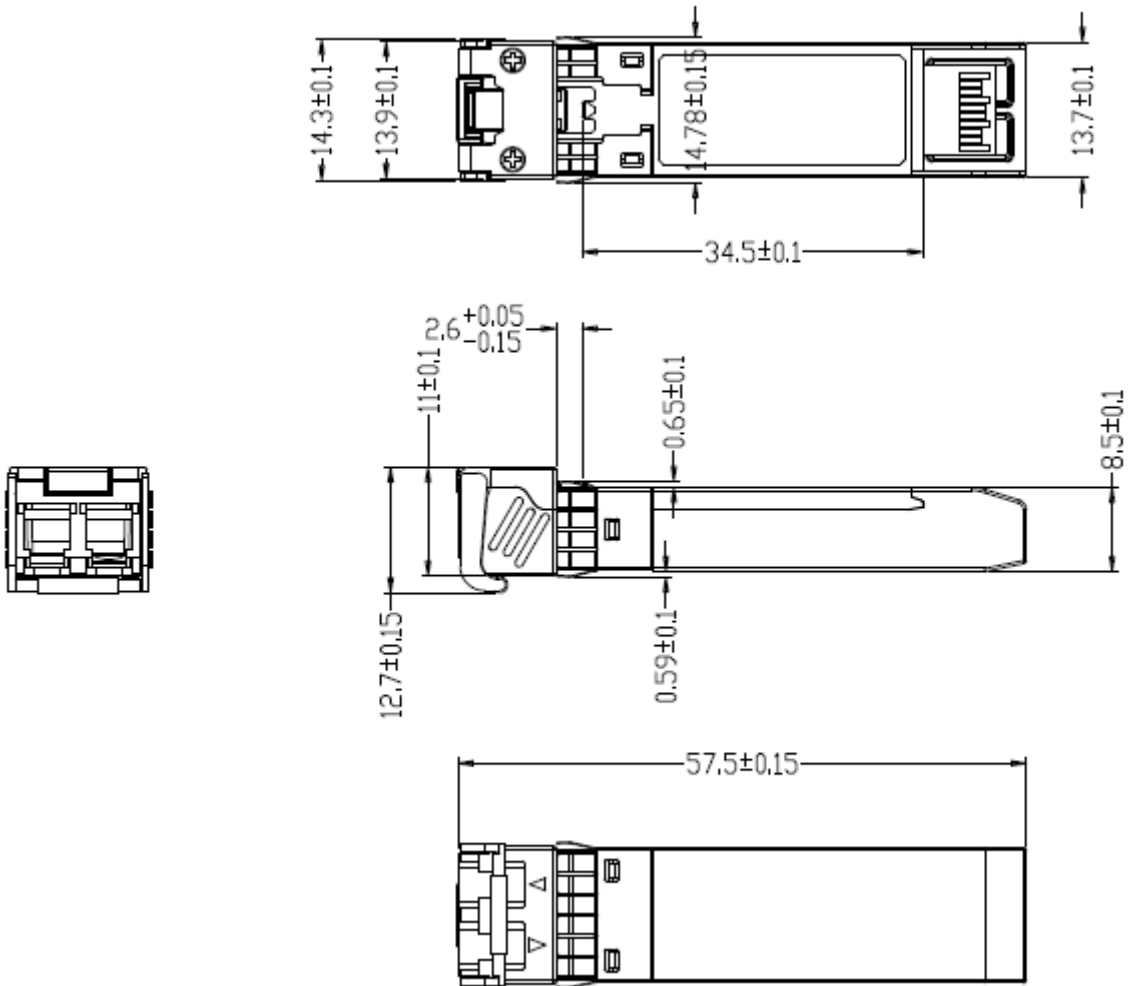

## Ordering information

Part Number	Product Description
OP-S16G31-20	14.025Gbps 1310nm LC 20km 0°C~+70°C with DDM