

OP-B1G53-20

1.25Gbps Bidi SFP, Tx1550nm/Rx1310nm 20KM Reach

Features

- Support 1.25Gb/s data rate
- Tx1550nm DFB laser transmitter and PIN photodetector
- Single 3.3V power supply
- Hot-pluggable SFP footprint
- Simplex LC/SC connector interface
- Metal Enclosure for lower EMI
- Up to 20km on 9/125μm SMF
- Compliant with SFP MSA and digital diagnostic SFF-8472
- Class 1 laser safety certified
- Compliant with RoHS



Applications

- 1x Fiber Channel
- WDM Gigabit Ethernet
- Switches and Routers
- Other Optical Links

Description

OPTINET Small Form Factor Pluggable (SFP) transceiver is designed for data communication on Single-mode fiber and transmission distance up to 20km. The transceiver consists of five sections: the DFB laser transmitter, the LD driver, the PIN photodiode, the limiting amplifier and the MCU control unit. And it compatible with Small Form Factor Pluggable Multi-Sourcing Agreement (MSA).

Absolute Maximum Ratings

Parameter	Symbol	Min.	Max.	Unit
Storage Temperature	Ts	-40	85	°C
Supply Voltage	Vcc	-0.5	4	V
Operating Humidity	RH	5	95	%
Power Consumption			1.2	W

Recommended Operating Conditions

Parameter		Symbol	Min.	Typical	Max.	Unit
Operating Temperature	Case Commercial	Tc	0		70	°C
	Extended	Tc	-10		85	°C



	Industrial	Tc	-40		85	°C
Power Supply Voltage		Vcc	3.15	3.3	3.45	V
Power Supply Current		Icc			300	mA
Data Rate		-		1.25		Gbps

Optical Characteristics

Parameter	Symbol	Min.	Typical	Max.	Unit
Transmitter					
Centre Wavelength	λ_c	1480	1550	1580	nm
Average Output Power	Po	-9		-3	dBm
Extinction Ratio	Er	9			dB
Spectral Width(RMS)	$\Delta\lambda$			1	nm
Optical Rise/Fall Time (20%~80%)	t_r/t_f			0.26	ns
Total Jitter	Tj			0.1	UI
Output Optical Eye Mask	Compliant with ITU-T G.957				
Receiver					
Center Wavelength	λ_c	1260		1360	nm
Receiver Sensitivity	S			-23	dBm
Receiver Overload	P _{in}	-3			dBm
LOS De-Assert	LOS _D			-24	dBm
LOS Assert	LOS _A	-35			dBm
LOS Hysteresis		1		4	dB

Notes:

1. The optical power is launched into 9/125 μ m SMF
2. PECL input, internally AC-coupled and terminated
3. Filtered measured with a PRBS 2⁷-1 test pattern @1.25Gbps, BER $\leq 1 \times 10^{-12}$

Electrical Characteristics

Parameter	Symbol	Min.	Typ.	Max.	Unit
Transmitter					
Data Input Swing Differential	V _{in}	400		2000	mV
Input Differential Impedence	Z _{in}	85	100	115	ohm
TX Disable	Disable		2	Vcc	V
	Enable		0	0.8	V
TX Fault	Fault		2	Vcc+0.3	V

	Normal		0		0.8	V
Receiver						
Data Output Swing Differential		Vout	400		2000	mV
Rx_LOS	High		2		Vcc+0.3	V
	Low		0		0.8	V

Digital Diagnostic Memory Map

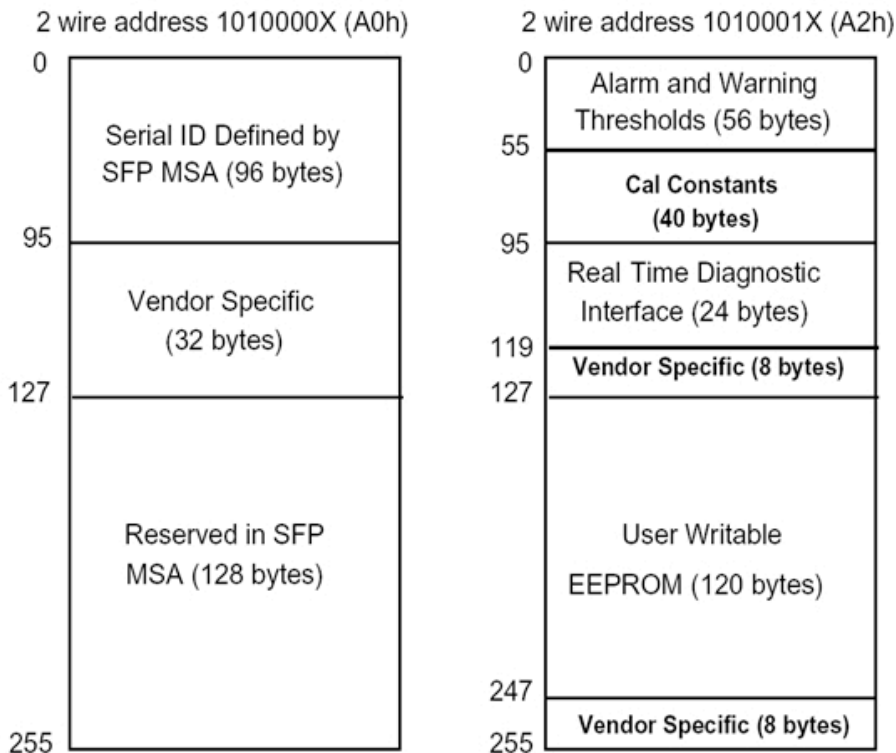

The SFP MAS defines a 256-byte memory map in EEPROM describing the transceiver's manufacturer, part no, standard interfaces, serial no and other information, which is accessible over a 2 wire serial interface at address A0h. The memory contents are shown in below table:

Addr.	Field Size (Bytes)	Name of Field	Hex	Description
0	1	Identifier	03	SFP
1	1	Ext. Identifier	04	MOD4
2	1	Connector	07	LC
3-10	8	Transceiver	XXX	1000Base-BX
11	1	Encoding	01	4B5B
12	1	BR, nominal	0D	1.25Gb/s



13	1	Reserved	00	
14	1	Length (9um)-km		
15	1	Length (9um)		
16	1	Length (50um)		20KM
17	1	Length (62.5um)		
18	1	Length (copper)	00	Not Compliant
19	1	Reserved	00	
20-35	16	Vendor name	57 49 4E 54 4F 50 20 20 20 20 20 20 20 20 20 20	
36	1	Reserved	00	
37-39	3	Vendor OUI	00 00 00	
40-55	16	Vendor PN	xx xx xx xx xx xx xx xx xx xx xx xx xx xx xx xx	根据公司(ASC II)
56-59	4	Vendor rev	31 2E 30 20	V1.0
60-61	2	Wavelength	06 0E	1550nm
62	1	Reserved	00	
63	1	CC BASE	XX	Check sum of bytes 0~62
64-65	2	Options	00 1A	LOS, TX_FAULT and TX_DISABLE
66	1	BR, max	00	
67	1	BR, min	00	
68-83	16	Vendor SN	xx xx xx xx xx xx xx xx xx xx xx xx xx xx xx xx	ASC II
84-91	8	Vendor date code	xx xx xx xx xx xx 20 20	Year, Month, Day
92	1	Diagnostic Monitoring type	XX	Diagnostics (External. Cal)
93	1	Enhanced option	XX	Optional Alarm/warning flags, Soft TX_FAULT and Soft TX_LOS monitoring)
94	1	SFF-8472	XX	Diagnostics (SFF-8472 Rev 9.4)
95	1	CC_EXT	XX	Check sum of bytes 64~94
96-255	160	Vendor specific		

The digital diagnostic monitoring interface also defines another 256-byte memory map in EEPROM, which makes use of the 8 bit address 1010001X (A2h). It allows real-time access to transceiver's

working temperature, laser bias current, transmitted optical power, receiver sensitivity and supply voltage. Please see Figure 2. for detailed information:

Parameter		Range	Accuracy	Calibration
Temperature	Commercial	0 to 70°C	±3°C	Internal
	Extended	-10 to 80°C	±3°C	Internal
	Industrial	-40 to 85°C	±3°C	Internal
Voltage		3.0 to 3.6V	±10%	Internal
Bias Current		0 to 100mA	±10%	Internal
Tx Power		-9 to -3	±3dB	Internal
Rx Power		-23 to -3	±3dB	Internal

Pin Definitions

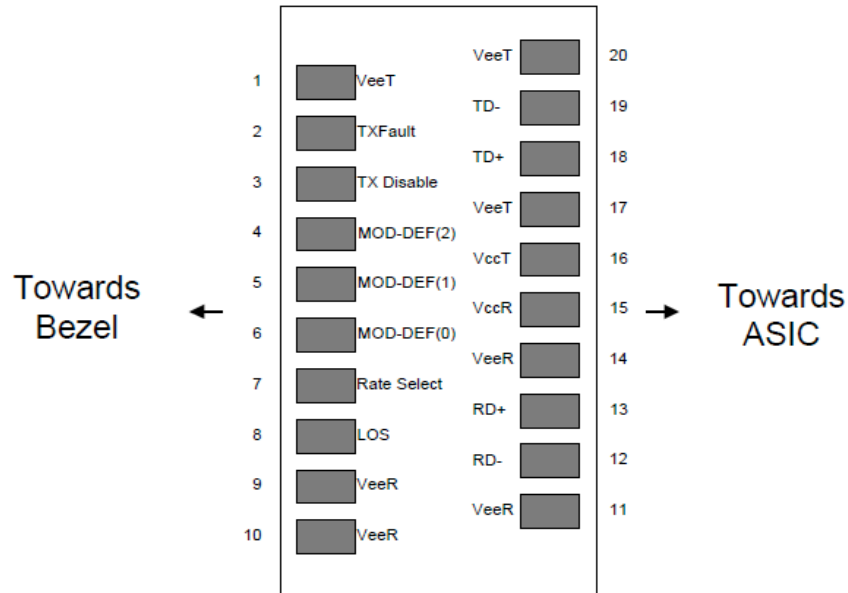

Diagram of Connector Block Pins on Host Board

Pins	Name	Description	NOTE
1	VeeT	Transmitter Ground	
2	Tx Fault	Transmitter Fault Indication	1
3	Tx Disable	Transmitter Disable	2
4	MOD DEF2	Module Definition 2	3
5	MOD DEF1	Module Definition 1	3
6	MOD DEF0	Module Definition 0	3
7	Rate Select	Not Connected	
8	LOS	Loss of Signal	4



9	VeeR	Receiver Ground	
10	VeeR	Receiver Ground	
11	VeeR	Receiver Ground	
12	RD-	Inv. Received Data Output	5
13	RD+	Received Data Output	5
14	VeeR	Receiver Ground	
15	VccR	Receiver Power	
16	VccT	Transmitter Power	
17	VeeT	Transmitter Ground	
18	TD+	Transmit Data Input	6
19	TD-	Inv. Transmit Data Input	6
20	VeeT	Transmitter Ground	

Notes:

1. TX Fault is an open collector output, which should be pulled up with a 4.7k~10kΩ resistor on the host board to a voltage between 2.0V and Vcc+0.3V. Logic 0 indicates normal operation; logic 1 indicates a laser fault of some kind. In the low state, the output will be pulled to less than 0.8V.
2. TX Disable is an input that is used to shut down the transmitter optical output. It is pulled up within the module with a 4.7k~10kΩ resistor. Its states are:
Low (0~0.8V): Transmitter on
(>0.8V, <2.0V): Undefined
High (2.0~3.3V): Transmitter Disabled
Open: Transmitter Disabled
3. MOD-DEF 0,1,2 are the module definition pins. They should be pulled up with a 4.7k~10kΩ resistor on the host board. The pull-up voltage shall be VccT or VccR.
MOD-DEF 0 is grounded by the module to indicate that the module is present
MOD-DEF 1 is the clock line of two wire serial interface for serial ID
MOD-DEF 2 is the data line of two wire serial interface for serial ID
4. LOS is an open collector output, which should be pulled up with a 4.7k~10kΩ resistor on the host board to a voltage between 2.0V and Vcc+0.3V. Logic 0 indicates normal operation; logic 1 indicates loss of signal. In the low state, the output will be pulled to less than 0.8V.
5. These are the differential receiver output. They are internally AC-coupled 100Ω differential lines which should be terminated with 100Ω (differential) at the user SERDES.
6. These are the differential transmitter inputs. They are AC-coupled, differential lines with 100Ω differential termination inside the module.

Recommended Interface Circuit

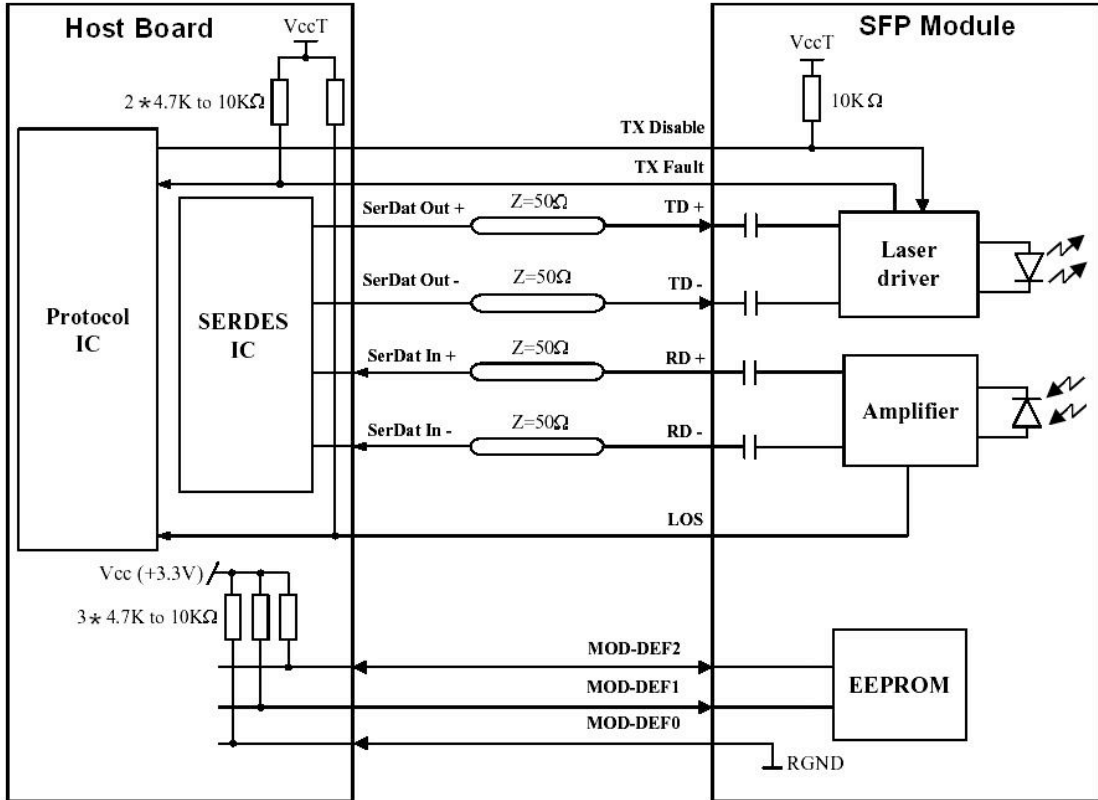

Mechanical Diagram

LC Connector

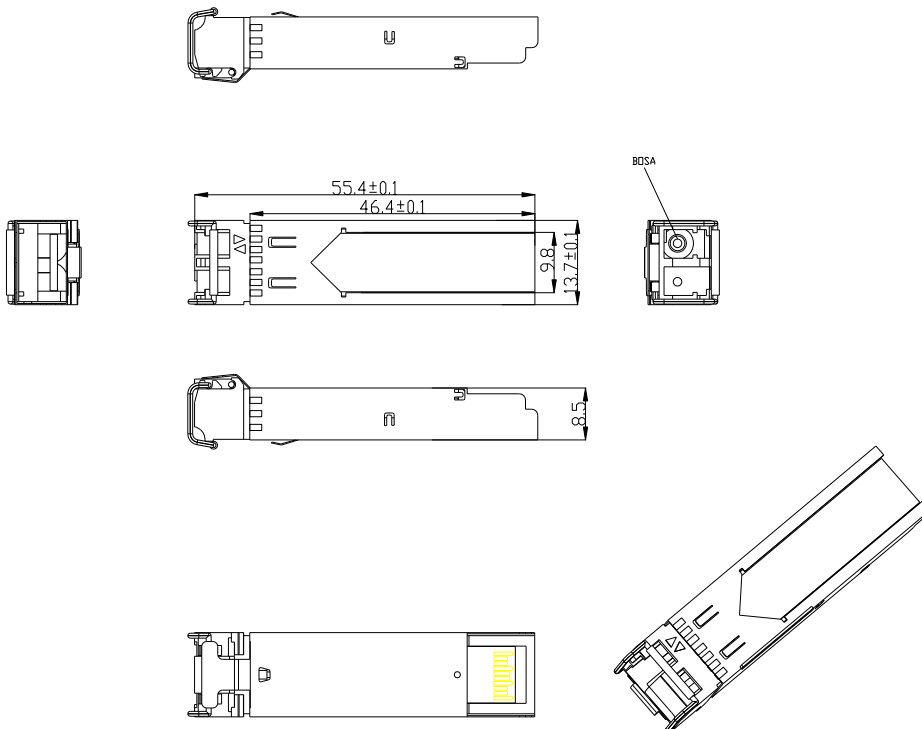

SC Connector

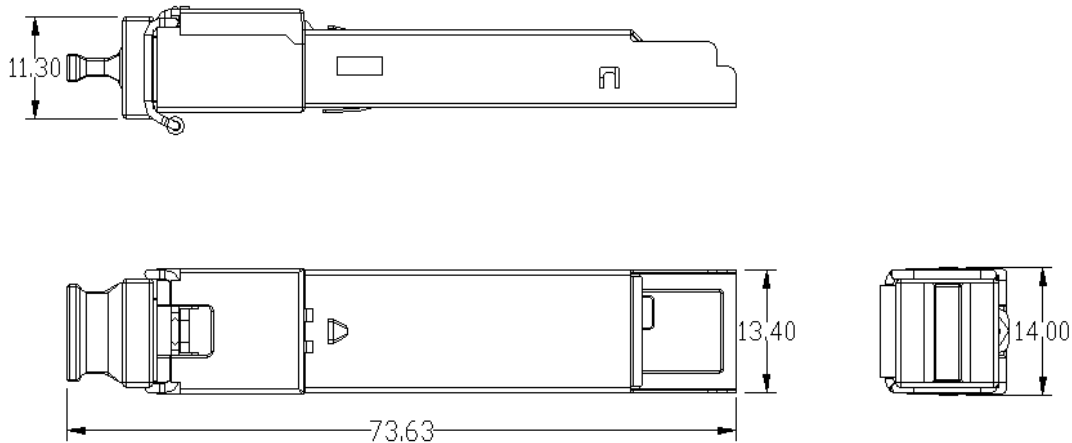

Ordering Information

Part No	Data Rate	Wavelength	Reach	Connector	Temp	DDM
OP-1G53-20LD	1.25Gb/s	Tx1550/RX1310nm	20KM	LC	0~70℃	Yes
OP-1G53-20IED	1.25Gb/s	Tx1550/RX1310nm	20KM	LC	-10~80℃	Yes
OP-1G53-20LID	1.25Gb/s	Tx1550/RX1310nm	20KM	LC	-45~85℃	Yes
OP-1G53-20SD	1.25Gb/s	Tx1550/RX1310nm	20KM	SC	0~70℃	Yes
OP-1G53-20SED	1.25Gb/s	Tx1550/RX1310nm	20KM	SC	-10~80℃	Yes
OP-1G53-20SID	1.25Gb/s	Tx1550/RX1310nm	20KM	SC	-45~85℃	Yes

Warnings

Handling Precautions: This device is susceptible to damage as a result of electrostatic discharge(ESD). A static free environment is highly recommended. Follow guidelines according to proper ESD procedures.

Laser Safety: Radiation emitted by laser devices can be dangerous to human eyes. Avoid eye exposure to direct or indirect radiation.